

AL

Recessed

AL is a recessed anti ligature emergency exit luminaire with slimline steel front fascia, secured to recessed housing with tamper proof screws. The high output, screen, provides a viewing distance of up to 36m.

- Colour temperatures: 4000°k.
- Colour Finishes: White as standard, Other RAL colours, available on request.
- ISO and EC legend panels available.
- Up to 36m viewing Distances.
- Rear Housing Cut-out: 422mm x 222mm required.
- Emergency options: Standard 3hr, Self-Test, DALI addressable or 3hr DALI Wireless Sentinel.

Technical

Product	AL
Mounting type	Recessed
Standard Sizes	315mm
Colour Temperature	Neutral White (4K)
Legend	Up Arrow
	Down Arrow
	Right Arrow
	Left Arrow
Emergency	3 hour, DALI, Self-Test, 3 hour DALI Wireless Sentinel
Rendering	Ra80+
IP Rating	IP20
Safety Class	Class 1
MacAdam	SDCM 2
Lifetime	>50K

Luminaire Order Builder

AL

STEP 1. Select Operation	STEP 2. Legend sign	STEP 3. CCT	STEP 4. Finish	STEP 5. Emergency
M3 Maintained 4.2W NM Non maintained	AL Exit sign left ISO Format AR Exit sign right ISO Format AU Exit sign up ISO Format AD Exit sign down ISO Format LA Exit sign left EC Format RA Exit sign right EC Format UA Exit sign up EC Format DA Exit sign down EC Format	4K 4000K	W White	E3 Standard 3 Hour ED DALI/EMPRO ES Self-Test EW* 3 hour DALI Wireless Sentinel

All electrical and optical data subject to $\pm 10\%$ tolerances.
*Reduced coverage

Example Code: ALM3AL4KWE3

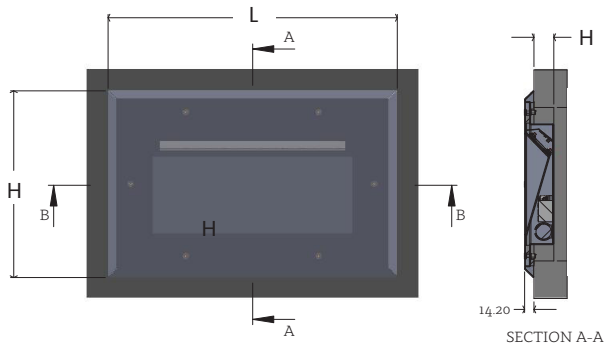









Dimensions

L	W	H	Finish	Code	Colour Swatch
436	286	44.2	White	W	

All dimensions are measured in millimetres (mm)

Exit Legends

ISO7010 Legends	Legend	Code	European (EC)	Legend	Code
	ISO Left Arrow	AL		EC Left Arrow	LA
	ISO Right Arrow	AR		EC Right Arrow	RA
	ISO Up Arrow	AU		EC Arrow Up	UA
	ISO Down Arrow	AD		EC Arrow Down	DA

IP20 IP20
Protection of fingers against access to hazardous parts, and protection against objects larger than 12.5mm



Safety Class
Class 1 Safety chassis is connected to earth with a separate terminal, instead of via the mains cable



Warranty
5 year Guarantee