

SubSpace 70

Surface

Subspace 70 is a surface linear architectural luminaire, manufactured from extruded aluminium, with a profile dimension of 73mm x 85mm. Supplied as Direct, in standard or custom lengths, with a variety of optics to suit your needs.

- Efficacy of up to 115 lm/W.
- LG7 Complaint, UGR<19 (when used with microprism diffuser).
- Colour temperatures: 3000°k, 4000°k or Tunable White (2700°k - 5700°k).
- Colour Finishes: White (9016), Black (9005) or Silver (9006). Other RAL colours, available on request.
- Dimming options: DALI 1-100% Dim, DSI, Switch Dim, 1-10v, DALI 10-100% Dim.
- Wireless control options: Casambi.
- Industry driver options: Fixed output or Dali dimming, for extended service life.
- Mounting bracket supplied as standard.
- Emergency options: Standard 3hr, Self-Test, Dali addressable or 3Hr Dali Wireless Sentinel.
- Square, or rectangular features are also available upon request*.
- Special projects, which may combine both wall & ceiling, using recessed, surface and suspended versions in a single line of light, are also available upon request*.
- Integrated PIR available upon request*.

Technical

Product	SubSpace 70
Mounting type	Surface
Standard Lengths	870-2970mm
Custom Lengths	140mm increments
Lumen/M	1100-5500 Lm/M
Efficacy	Up to 115 Lm/W
Colour Temperature	Warm White (3K)
	Neutral White (4K)
	Tunable White (2.7K >5.7K)
Optics	Opal diffuser
	Microprism (UGR<19)
Control	DALI 1-100%, DSI, 1-10V, Casambi, Fixed Output, Industry DALI, Industry Fixed Output, DALI 10-100%
Emergency	3 hour, DALI, Self-Test, 3 hour DALI Wireless Sentinel
Rendering	Ra80+
IP Rating	IP20
Safety Class	Class 1
MacAdam	SDCM 3
L70/B10	>75K

* Please contact P&A Technical Department for assistance

P&A SubSpace 70

Luminaire Order Builder

SS70-SF

STEP 1. Select Current	STEP 2. Optics	STEP 3. Length	STEP 4. CCT	STEP 5. Control	STEP 6. Finish	STEP 7. Emergency
15 150mA 1100 Lm/M - 10W/m	O Opal Diffuser	870 870mm	3K 3000K	FO Fixed Output	W RAL9016M	E3 Standard 3 Hour
20 200mA 1500 Lm/M - 140W/m	M Microprism UGR<19	1150 1150mm	4K 4000K	A1 DALI 1-100% Dim	B RAL9005	ED DALI/EMPRO
25 250mA 1900 Lm/M - 17W/m		1430 1430mm	TW 2700K - 5700K Tunable white	A2 DSI	S RAL9006	ES Self-Test
30 300mA 2200 Lm/M - 20W/m		1710 1710mm		A3 Switch Dim	Z Custom	EW 3 hour DALI Wireless Sentinel
35 350mA 2600 Lm/M - 24W/m		1990 1990mm		A4 1-10v		
40 400mA 3000 Lm/M - 27W/m		2270 2270mm		A5 Casambi		
		2550 2550mm		A6 Industry Fixed Output		
		2970 2970mm		A7 Industry DALI		
		XXXX Insert custom length (mm)		A8 DALI 10-100% Dim		

All electrical and optical data subject to $\pm 10\%$ tolerances.
Values based on 4000K Colour temperature.

Example Code: SS70SF15011504KA1WE3

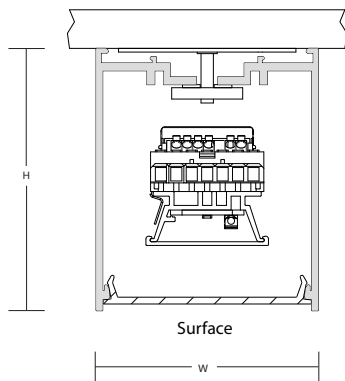

Dimensions

L	W	H
870	73	85
1150	73	85
1430	73	85
1710	73	85
1990	73	85
2270	73	85
2550	73	85
2970	73	85
Custom*	73	85

All dimensions are measured in millimetres (mm).
*Custom lengths upon request.

Finish

RAL	Code	Colour Swatch
White	9016M	
Black	9005	
Silver	9006	
Custom*	Custom*	

*Custom Colours upon request.



Crown house, Plantation Rd, Burscough, Lancashire, L40 8JT
01704 891333
sales@pandaprojects.co.uk
www.pandaprojects.co.uk

Datasheet Code: PA-10453-0

